

Mecanismos cisterna y accesorios WC	1 - 4
Accesorios PVC	5 - 6
Válvulas esfera	7 - 8
Racorería de latón	9 - 12
Sifones y válvulas	13 - 17
Grifería y complementos	18 - 23
Conexiones	24
Ducha, mangos y flexos	25 - 27
Fijación	28 - 29
Soportes	30
Gas natural y butano	31
Ventilación	32
Juntas	33 - 35
Soldadura	36
Varios	37
Calefacción	38
Accesorios y tubería de cobre	39 - 40
Accesorios latón - soldar	41
Racorería para tubo polietileno	42
Condiciones de venta	

VÁLVULAS DESCARGA

VÁLVULA DESCARGA TANQUE ALTO



CÓDIGO		€
01101	peso plomo	10,40
01102	muelle	11,12
01103	plomo REFORZADA	12,46
01104	plomo GIGANTE	14,80
01105	PVC tipo I	4,24

VÁLVULA DESCARGA ELÉCTRICA



01137

CÓDIGO		€
01137	220 V.	47,46
01200	bobina eléctrica	20,98
01201	boya con varilla	6,04

VÁLVULA DESCARGA INTERMITENTE



CÓDIGO		€
01100	nº 1 latón	40,54

VÁLVULA DESCARGA TANQUE BAJO



CÓDIGO	MEDIDA	€
01106	PVC 'FOM'	5,90
01107	universal	4,10
01153	universal 'I'	5,88
01096	tipo 'ROCA'	8,30

VÁLV. DESCARGA TANQUE BAJO INTERRUPTIBLE

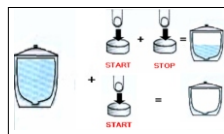

01097

CÓDIGO	MEDIDA	€
01097	PVC ahorro de agua Pulsador único	24,00
07055	pulsador latón cromado	5,26
01095	PVC doble pulsador Doble pulsador	28,98
07054	doble pulsador l.crom.	4,80



01095

FLOTADORES

OLLETA CIERRE TEFLÓN



CÓDIGO	MEDIDA	€
01109	3/8"	3,36
01112	1/2"	6,44
01133	3/4"	9,40

SILENCIOSO CIERRE TEFLÓN



CÓDIGO	MEDIDA	€
01110	3/8" tanque alto	3,38
01111	3/8" tanque bajo	3,92

RECOVAL

GUÍAS CIERRE INOX

CÓDIGO	MEDIDA	€
07113	1/2"	6,10
07114	3/4"	8,38
07115	1"	10,90
07116	1"1/4	48,32
07117	1"1/2	63,60
07118	2"	70,00



PALANCA

CÓDIGO		€
01114	soporte latón normal	1,84
01136	soporte latón SUPER	2,40



TORNILLO PALANCA

CÓDIGO		€
01130	acero inox.	0,26



TELESCÓPICO TANQUE BAJO

CÓDIGO	MEDIDA	€
01131	3/8" con boya inferior	8,36



BOYA ESPUMA

CÓDIGO	MEDIDA	€
01116	3/8"	0,60
01117	1/2"	1,10
01118	3/4"	1,76

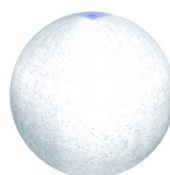

SILENCIOSO CON BOYA LATERAL

CÓDIGO	MEDIDA	€
01139	3/8"	5,32



BOYA PLÁSTICO

CÓDIGO	MEDIDA	€
01119	3/8"	0,88
01120	1/2"	1,76
01121	3/4"	2,38
01134	1"	3,08
01135	1"1/4 - 1"1/2	4,88
01025	2"	6,00



FLOTADORES COMPACTO ROSCA LATÓN

CÓDIGO	MEDIDA	€
01138	FLUIDMASTER inferior	22,28
01416	FLUIDMASTER lateral	23,24
01108	FL-90 SERVO inferior	19,52
01407	FL-90 SERVO lateral	14,76
01154	Servo-válvula inferior "I"	12,80
01155	Servo-válvula lateral "I"	13,32



01416



01138



01407



01108



01155



01154

TIRADOR TANQUE ALTO

CÓDIGO		€
01124	económico plástico	1,16
01125	plano	1,80
01126	anilla	2,22



01124

01125

01126

TIRADOR TANQUE BAJO

CÓDIGO		€
01150	recto pomo metal	2,10
01151	recto pomo ABS	1,50
01127	curvo pomo metal	2,10
01202	curvo pomo ABS	1,50



01150

BOYA SIFÓNICA TANQUE BAJO

CÓDIGO		€
01128	con varilla	2,60



CONJUNTO CISTERNA TANQUE ALTO



01129

CÓDIGO		€
01129	ECONÓMICO	18,20
01129RF	REFORZADO descarga reforzada	20.80
01129ES	REFORZ. ESPECIAL flotador silencioso palanca super descarga reforzada	22.50



01129ES

CISTERNA TANQUE ALTO



07246

CÓDIGO		€
03174	SUPER S-171	16,02
07246	económica	4,14
07247	accesorios cisterna eco.	10,30

BAJANTE TANQUE ALTO



CÓDIGO		€
03134	completo	5,28

ENCHUFE INODORO

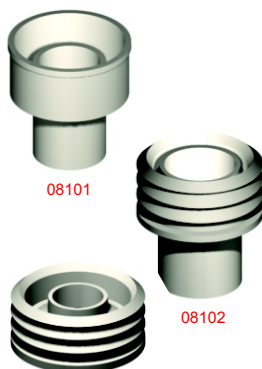

08101

08102

08217

CÓDIGO		€
08101	tipo CAMPANA 30	0,66
08195	tipo CAMPANA 25	0,66
08102	tipo PRESIÓN	0,76
08217	tipo VICTORIA	0,84

VALVULA INSA Y RECAMBIOS

NOVEDAD

MEMBRANA TIRADOR DESCARGA 'INSA'



CÓDIGO		€
08215	Negra, roja o azul	6,60

SOBREDESCARGA TIRADOR



CÓDIGO	MEDIDA	€
01190		36,04

RECAMBIOS VALVULA INSA

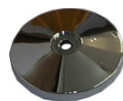
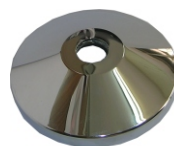

CÓDIGO		€
DT-12	Florón cromado ABS	13,30
DT-6	capsula con rosca	11.14
DT-13	pomo cromado ABS	4,20
DT-4	plaqueta latón	1,40
DT-5	eje roscado	4.64
DT-9	arandela cromada ABS	4,32
DT-11	tornillo latón cromado	2,20
DT-15	muelle descarga	2,80
DT-7	tuerca latón 3/16x15	1,00

RECOVAL

TAPAS Y LLAVES REGULACIÓN

TAPAS ABS WC

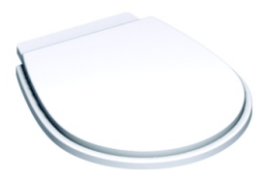

CÓDIGO		€
07245	'UNIVERSAL' económica	8,80
07179	'CONTINENTAL'	16,30
07267	'LUCIAN'	25,64
07379	'TAPIDET'	152,00
	Tapa WC LUJO. Para uso bidet	
	Completa	

JUEGO TORNILLOS TAPA WC



07414



07415

CÓDIGO		€
07414	económico (2 unidades)	0,80
07415	'LUCIAN' (2 unidades)	3,45

MANGUITO ELASTICO PARA EVACUACION



CÓDIGO	MEDIDA	€
03227	Magic coude Ø 32	5,30
03228	Magic coude Ø 40	5,54
03229	Magic coude Ø 50	7,36

MANGUITOS DESAGÜE W.C.

MANGUITO PVC



CÓDIGO		€
03169	extensible de 23 a 57 cm	14,80
03145	flexible largo 40 cm	16,00
03206	orientable de 0° a 90°	14,84

MANGUITO GOMA FLEXIBLE



CÓDIGO		€
03176	recto	3,60
03177	excéntrico	3,60

MANGUITO PVC GRIS

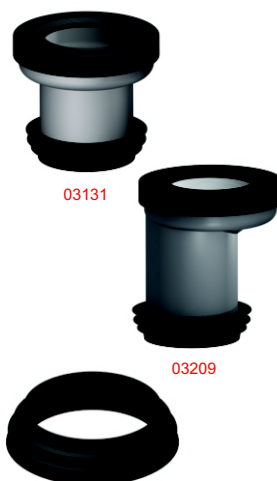

03131

03209

03133

CÓDIGO	MEDIDA	€
03131	Ø 90 recto (2 gomas)	3,70
03209	Ø 90 excéntrico(2 gomas)	3,70
03132	Ø 110 recto	3,70
03138	Ø 110 excéntrico	3,70
03133	goma labiada	0,80

ACCESORIO PRESION PVC

NOVEDAD

CODO 90° HEMBRA-HEMBRA



CÓDIGO	MEDIDA	€
03054	20 mm	0,46
03055	25 mm	0,62

CODO 45° HEMBRA-HEMBRA



CÓDIGO	MEDIDA	€
03056	20 mm	0,66
03057	25 mm	0,84

MANGUITO HEMBRA-HEMBRA

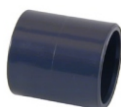

CÓDIGO	MEDIDA	€
03058	20 mm	0,60
03059	25 mm	0,66

TAPON HEMBRA



CÓDIGO	MEDIDA	€
03060	20 mm	0,40
03061	25 mm	0,40
03062	32 mm	0,62
03063	40 mm	0,96

TE IGUAL 90° HEMBRA



CÓDIGO	MEDIDA	€
03064	20 mm	0,60

CASQUILLO REDUCTOR

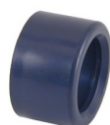

CÓDIGO	MEDIDA	€
03065	25 - 20 mm	0,40
03066	32 - 20 mm	0,46
03067	32 - 25 mm	0,40
03068	40 - 20 mm	0,60
03069	40 - 25 mm	0,60

ACCESORIO EVACUACION PVC

ROLLO HIDROTUBO



CÓDIGO	MEDIDA	€
03213	Ø 20 mm (precio/metro)	1,60
03225	Ø 25 mm	1,78
03140	Ø 32 mm	2,38
03141	Ø 40 mm	3,20
03165	Ø 50 mm	3,98

TUBO Y BOTES ADHESIVO PARA PVC



07148

CÓDIGO	MEDIDA	€
07148	Tubo 125 ml	1,84
07627	Bote 1/4 Kilo	4,20
07376	Bote 1/2 kilo	9,04
07416	Bote 1 kilo	13,70

TIJERA CORTATUBOS



CÓDIGO	MEDIDA	€
03196	tijera cortatubos PVC	18,88
03233	tijera INOX cortatubos	43,44
03032	cuchilla recambio tijera PVC	10,20

RECOVAL

MANGUITO H - H



CÓDIGO	MEDIDA	€
03123	32 mm	0,70
03124	40 mm	0,64
03117	50 mm	1,00

CODO 87,5° M - H



CÓDIGO	MEDIDA	€
03144	32 mm	0,70
03166	40 mm	0,88
03205	50 mm	1,12
03192	110 mm	2,72

CODO 87,5° H - H



CÓDIGO	MEDIDA	€
03125	32 mm	0,40
03127	40 mm	0,44
03126	50 mm	1,12
03148	110 mm	2,00

CODO 45° M - H



CÓDIGO	MEDIDA	€
03254	32 mm	0,66
03222	40 mm	0,90
03240	50 mm	1,54
03231	110 mm	2,20

CODO 45° H - H



CÓDIGO	MEDIDA	€
03216	32 mm	0,60
03218	40 mm	0,60
03239	50 mm	1,24
03238	110 mm	2,32

CODO 67,5° H - H



CÓDIGO	MEDIDA	€
03214	32 mm	0,80
03217	40 mm	0,90
03241	50 mm	2,32

TE H - H

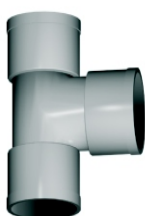

CÓDIGO	MEDIDA	€
03128	32 mm	0,70
03137	40 mm	0,80
03168	50 mm	1,40
03142	110 mm	4,12

INJERTO PARA TUBO

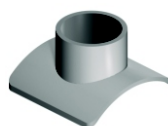

CÓDIGO	MEDIDA	€
03210	40 mm - 110 mm	1,14
03211	50 mm - 110 mm	1,14

GOMA UNIÓN TUBO PVC - METAL



CÓDIGO	€
08179	0,70

TE DERIVACIÓN 45° H - H



CÓDIGO	MEDIDA	€
03191	32 mm	0,84
03190	40 mm	0,96
03193	50 mm	1,80

TAPÓN PVC



CÓDIGO	MEDIDA	€
03135	M 1/2"	0,12
03136	M 3/4"	0,16

CASQUILLO REDUCTOR

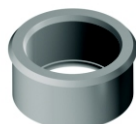

CÓDIGO	MEDIDA	€
03129	40 - 32 mm	0,40
03130	50 - 40 mm	0,44

TAPÓN PVC CIEGO



CÓDIGO	MEDIDA	€
03070	40	0,68

VALVULAS DE ESFERA

RECOVAL

VÁLVULA ESFERA PASO TOTAL



CÓDIGO	MEDIDA	€
01140	1/4"	4,20
01141	3/8"	3,02
01142	1/2"	3,22
01143	3/4"	4,88
01144	1"	6,48
01145	1"1/4	11,32
01146	1"1/2	18,04
01147	2"	29,20

VÁLVULA ESFERA SOLDAR VISTA

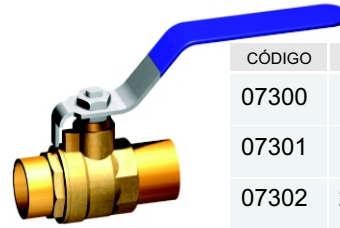

CÓDIGO	MEDIDA	€
07300	15 mm.	4,40
07301	18 mm.	4,40
07302	22 mm.	5,60

VÁLVULA ESFERA MINI



CÓDIGO	MEDIDA	€
07438	H - H 3/8"	3,00
07429	H - H 1/2"	3,24
07625	M - H 3/8"	3,00
07613	M - H 1/2"	3,00

NOVEDAD



FABRICADO EN C.E.

01142RF	1/2" REFORZADA	6,48
01143RF	3/4" REFORZADA	9,24
01144RF	1" REFORZADA	12,90



VÁLVULA ESFERA SOLDAR EMP. COMPLETA



CÓDIGO	MEDIDA	€
07342	15 mm.	10,36
07343	18 mm.	10,46
07344	22 mm.	11,20



T.M.M.

01149	1/2" TMM C-501	11,88
01430	3/4" TMM C-501	16,08
	RACORT RÁPIDO	

GRIFO ESFERA JARDÍN RACOR MANGUERA



CÓDIGO	MEDIDA	€
07227	1/2"	3,46
07228	3/4"	5,66
07229	1"	7,70

VÁLVULA ESFERA SOLDAR EMPOTRAR



CÓDIGO	MEDIDA	€
07184	15 mm.	5,80
07185	18 mm.	5,80
07186	22 mm.	7,30



T.M.M.

07217	1/2" TMM C-400ER	14,80
07219	3/4" TMM C-400ER	19,70
	RACORT RÁPIDO	

GRIFO MANGUERA 1/2 DOBLE SALIDA 3/4



CÓDIGO	MEDIDA	€
07268		12,00

MANDO CON FLORÓN



CÓDIGO	MEDIDA	€
07450	oculto	3,90
07451	redondo	3,90
07452	palanca	3,90

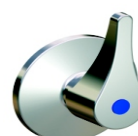
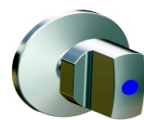

RECOVAL

GRIFO CODILLO PULIDO

	CÓDIGO	MEDIDA	€
	07215	1/2"	4,76
	07220	1/2" racort manguera	7,40

GRIFO CODO BALEAR

	CÓDIGO	MEDIDA	€
	07242	1/2" fabricado en latón Con caño giratorio	54,00

GRIFOS DE JARDÍN DECORATIVOS

	CÓDIGO		€
	07888	RENACIMIENTO 1/2" fabricado en latón Cierre 1/4 de vuelta	20,00
	07889	RENACIMIENTO 1/2" latón. Vol. redondo Montura normal	20,00

07888

LATÓN			
	07394	modelo GALLO	18,00
	07395	modelo PATO	20,00
	07390	modelo CABALLO	18,00
	07392	modelo RANA	20,00
	07393	modelo PAJARO	18,00
	07396	modelo PEZ	18,00
	07391	modelo CARACOL	20,00

07395

07396

LATÓN ENVEJECIDO			
	07394EN	modelo GALLO	18,00
	07395EN	modelo PATO	20,00
	07390EN	modelo CABALLO	18,00
	07392EN	modelo RANA	20,00
	07393EN	modelo PAJARO	18,00
	07396EN	modelo PEZ	18,00
	07391EN	modelo CARACOL	20,00
	07399EN	modelo ARDILLA	20,00

07392EN

VÁLVULA REDUCTORA DE PRESIÓN

	CÓDIGO	MEDIDA	€
	01182	1/2"	21,56
	01181	3/4"	26,50
	01180	1"	61,00

VÁLVULA RETENCIÓN

	CÓDIGO	MEDIDA	€
	01164	1/2"	2,94
	01165	3/4"	3,68
	01166	1"	7,30
	01167	1"1/4	10,58
	01168	1"1/2	13,90
	01169	2"	20,92

FILTRO INOX. PARA VÁLVULA DE RETENCIÓN

	CÓDIGO	MEDIDA	€
	01174	1/2"	1,26
	01175	3/4"	1,54
	01176	1"	1,78
	01177	1"1/4	2,10
	01178	1"1/2	2,36
	01179	2"	2,80

FILTRO INCLINADO 'Y'

	CÓDIGO	MEDIDA	€
	07330	1/2"	5,28
	07331	3/4"	6,00
	07332	1"	8,64
	07337	1"1/4	15,58

CONTADOR DE AGUA

	CÓDIGO	MEDIDA	€
	02412	1/2"	40,50
	04136	3/4"	52,00

RACOR MARSELLA M - H



CÓDIGO	MEDIDA	€
02099	3/8"	0,56
02100	1/2"	0,90
02327	1/2" 2 cm	1,36
02101	3/4"	1,36
02102	1"	2,42
02103	1"1/4	4,50
02098	1"1/2	6,92
	CROMADO	
02272	3/8"	0,76
02277	1/2"	1,18
02278	3/4"	1,96

MACHÓN CONTRARROSCA M - M



CÓDIGO	MEDIDA	€
02121	3/8"	0,56
02122	1/2"	0,70
02123	3/4"	1,20
02124	1"	2,18
02125	1"1/4	4,24
02126	1"1/2	5,86
02127	2"	8,76
02276	2"1/2	12,30
02187	3"	20,00
	CROMADO	
02273	3/8"	0,82
02137	1/2"	1,16

RACOR MARSELLA REDUCCIÓN M - H



CÓDIGO	MEDIDA	€
02096	M 1/4" - H 3/8"	1,64
02097	M 1/8" - H 1/4"	1,32
02105	M 1/2" - H 3/8"	0,86
02106	M 3/8" - H 1/2"	0,82
02107	M 3/4" - H 1/2"	1,56
02108	M 1/2" - H 3/4"	1,46
02109	M 1" - H 3/4"	3,14
02110	M 3/4" - H 1"	2,06
02176	M 3/4" - H 1"1/4	4,26
02197	M 1" - H 1/2"	3,64
02112	M 1" - H 1"1/4	4,40
02114	M 1"1/4 - H 1"1/2	5,66
02116	M 1"1/2 - H 2"	10,08
02117	M 1/2" - H 1"	2,08
	CROMADO	
02275	M 3/8" - H 1/2"	1,06
02299	M 1/2"- H 3/4"	1,70

MACHÓN CONTRARROSCA REDUCCIÓN M - M



CÓDIGO	MEDIDA	€
02294	1/4" - 1/8"	1,30
02128	1/4" - 3/8"	1,10
02129	1/2" - 3/8"	0,64
02131	1/2"- 3/4"	1,06
02416	7/8" - 3/4	3,06
02134	1" - 1/2	1,74
02132	1" - 3/4"	1,84
02330	1"1/4 - 1/2"	8,00
02312	1"1/4 - 3/4"	4,16
02133	1"1/4 - 1"	4,42
02314	1"1/2 - 3/4"	5,46
02159	1"1/2 - 1"	5,20
02135	1"1/2 - 1"1/4	5,46
02333	2" - 1"	8,72
02319	2" - 1"1/4	7,80
02136	2" - 1"1/2	8,54
02315	2"1/2 - 2"	17,00
	CROMADO	
02130	1/2" - 3/8"	0,72
02262	1/2" - 3/8" largo	1,20



RECOVAL

CONJUNTO MONOBLOC LATÓN CROMADO



CÓDIGO	MEDIDA	€
02160	corto 1/2" x 3/8"	1,44
02161	largo 1/2" x 3/8"	1,60

TAPÓN M



CÓDIGO	MEDIDA	€
02150	3/8"	0,50
02151	1/2"	0,66
02152	3/4"	1,08
02153	1"	1,72
02179	1"1/4	3,10
02177	1"1/2	3,58
02178	2"	7,56

TAPÓN H



CÓDIGO	MEDIDA	€
02155	3/8"	0,40
02156	1/2"	0,54
02157	3/4"	0,92
02158	1"	2,08
02317	1"1/4	2,80

MANGUITO



CÓDIGO	MEDIDA	€
02180	3/8"	1,14
02164	1/2"	1,32
02165	3/4"	1,90
02166	1"	2,94
02141	1"1/4	4,42

MANGUITO REDUCCIÓN H - H



CÓDIGO	MEDIDA	€
02336	3/8" - 1/2"	1,86
02301	1/2" - 3/4"	2,06
02334	3/4" - 1"	2,00
02115	1" - 1"1/4	3,90
02113	1"1/4 - 1"1/2	6,00

CONJUNTO MONOBLOC CODO L. CROMADO



CÓDIGO	MEDIDA	€
02290	codo M 1/2" - M 3/8"	2,40
02283	cjto. monobloc sin florón	3,04
02162	cjto. monobloc 90° c/ fl. cjto. monobloc 45° c/ fl.	3,24

CODO M - H



CÓDIGO	MEDIDA	€
02111	3/8"	2,02
02173	1/2"	1,62
02174	3/4"	2,20
02175	1"	3,26
02142	1"1/4	7,02

CODO H - H



CÓDIGO	MEDIDA	€
02181	3/8"	1,90
02167	1/2"	1,48
02168	3/4"	2,20
02169	1"	3,40
02326	1"1/4	5,00
02339	1"1/2	7,22

TE H - H



CÓDIGO	MEDIDA	€
02182	3/8"	2,18
02170	1/2"	1,90
02171	3/4"	3,20
02172	1"	4,30
02324	1"1/4	9,26
02325	1"1/2	11,40

REDUCCIÓN HEXAGONAL M - H



CÓDIGO	MEDIDA	€
02143	3/8" - 1/4"	0,62
02144	1/2" - 3/8"	0,54
02145	3/4" - 1/2"	0,90
02146	1" - 3/4"	1,60
02147	1"1/4 - 1"	3,00
02148	1"1/2 - 1"1/4	3,58
02149	2" - 1"1/2	6,42
02270	1" - 1/2"	2,02

UNIÓN 3 PIEZAS H - H



CÓDIGO	MEDIDA	€
02406	1/2"	6,80
02407	3/4"	8,06
02408	1"	8,60
02409	1"1/4	11,26
02410	1"1/2	14,12
02411	2"	18,24

RACOR BARCELONA



CÓDIGO	MEDIDA	€
02203	1/2" = 20 mm.	6,10
02204	3/4" = 25mm.	9,02
02205	1" = 30 mm.	10,86
02206	1"1/4 = 35 mm.	17,82

GOMA RACOR BARCELONA



CÓDIGO	MEDIDA	€
08190	1/2" = 20 mm.	0,36
08191	3/4" = 25mm.	0,36
08192	1" = 30 mm.	0,36
08193	1"1/4 = 35 mm.	0,56

ARANDELA CHAPA HIERRO ZINCADO

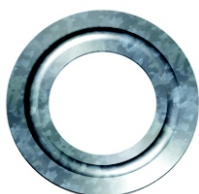

CÓDIGO	MEDIDA	€
07305	3/8"	0,10
07306	1/2"	0,14
07307	3/4"	0,18
07308	1"	0,20
07323	1"1/4	0,32
07324	1"1/2	0,52
07325	2"	0,64

RACOR DOS PIEZAS MANGUERA



CÓDIGO	MEDIDA	€
02194	1/2"	0,96
02195	3/4"	1,50
02196	1"	2,40

ENTRONQUE MANGUERA



CÓDIGO	MEDIDA	€
02188	3/8"	1,54
02189	1/2"	1,50
02190	3/4"	1,70
02191	1"	2,46
02305	1"1/4	3,80
02306	1"1/2	4,20

RACOR DEPÓSITO URALITA



CÓDIGO	MEDIDA	€
02209	3/8"	2,24
02210	1/2"	2,30
02211	3/4"	3,00
02212	1"	5,22
02213	1"1/4	7,08
02214	1"1/2	8,00
02215	2"	15,00

TUERCA CORREDERA



CÓDIGO	MEDIDA	€
02183	3/8"	0,80
02184	1/2"	0,82
02185	3/4"	0,84
02186	1"	1,90

ARANDELA CHAPA LATÓN



CÓDIGO	MEDIDA	€
07326	1/2"	0,58
07327	3/4"	0,62
07328	1"	0,92
07329	1"1/4	1,30
07340	1"1/2	1,70
07341	2"	1,96

RECOVAL

TUERCA LATÓN CROMADO y accesorios

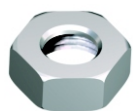

CÓDIGO	MEDIDA	€
02231	3/8" - 10	0,50
02232	1/2" - 10	0,64
02268	1/2" - 12	0,64
07318	arandela alum. 3/8" - 10	0,08
08182	junta tórica 3/8" - 10	0,05



07318



08182

FLORÓN INOX.



CÓDIGO	MEDIDA	€
07316	3/8" plano	0,18
07135	1/2" plano	0,18
07137	3/4"	0,36
07136	1/2" patas	0,20
07134	1/2" bombeado	0,18
07201	doble bombeado	0,32
07351	TARRACO	0,70
07183	TARRACO especial	1,08

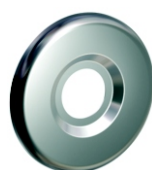

MANGUITO ELECTROLISIS



07133

CÓDIGO	MEDIDA	€
07128	1/2"	1,56
07129	3/4"	1,92
07130	1"	2,76
07131	1"1/4	11,98
07653	1"1/2	20,44
07654	2"	34,86
07133	1/2 "M - H fibra vidrio	1,08

COLLARÍN CIEGO O CON TOMA

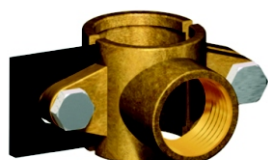

CÓDIGO	MEDIDA	€
02224	1/2" = 20 mm	5,98
02225	3/4" = 25 mm	6,58
02226	1" = 30 mm	9,72
02227	1"1/4 = 35 mm	13,78
02228	1"1/2 = 50 mm	17,70
02229	2" = 63 mm	20,00
02230	2"1/2 = 75 mm	28,40

ALARGO PARA GRIFO



CÓDIGO	MEDIDA	€
	PULIDO	
02218	1/2" x 3 cm.	1,72
02219	1/2" x 5 cm.	1,96
02220	1/2" x 10 cm	3,00
	CROMADO	
02221	1/2" x 3 cm.	1,90
02222	1/2" x 5 cm.	2,20
02223	1/2" x 10 cm.	3,54

TAPAPOROS COBRE



CÓDIGO	MEDIDA	€
02192	15 mm.	12,10
02238	18 mm.	12,54
02293	22 mm.	14,24
02338	28 mm.	16,40

TAPAPOROS HIERRO GALVANIZADO



CÓDIGO	MEDIDA	€
02390	1/2"	10,60
02391	3/4"	11,16
02392	1"	13,32

JUNTA DOBLE HIERRO GALVANIZADO KK



CÓDIGO	MEDIDA	€
02770	1/2"	15,58
02771	3/4"	16,70
02772	1"	19,82

JUNTA H HIERRO GALVANIZADO KI



CÓDIGO	MEDIDA	€
02740	1/2"	10,12
02741	3/4"	11,48
02742	1"	12,74

JUNTA M HIERRO GALVANIZADO KA



CÓDIGO	MEDIDA	€
02746	1/2"	10,12
02747	3/4"	11,48
02748	1"	12,74

SIFONES DE GOMA FLEXIBLE

	CÓDIGO	MEDIDA	€
	03101	25/30 abierto	1,92
	03102	30/30 abierto	1,92
	03103	35/35 abierto	1,92
	03097	35/40 abierto	1,92
	03098	40/40 abierto	2,10
	03105	30/30 cerrado	2,08
	03106	35/35 cerrado	2,08
	03104	40/40 cerrado	2,16
	03219	doble con toma	6,52

SIFÓN LATÓN CROMADO PARA LAVABO

	CÓDIGO	MEDIDA	€
	03109	1"1/4	13,90
	03201	1"1/4 giratorio	13,96
	03121	"Milenium"	36,00
	03248	"Picasso"	46,00

NOVEDAD

SIFONES ABS

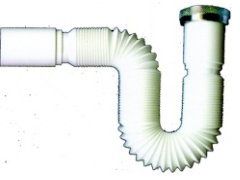
	CÓDIGO	MEDIDA	€
	03172	1"1/4 extensible racor metálico	5,80
	03173	1"1/2 extensible racor metálico	5,80
	03220	1"1/4 extensible cromado	6,38
	03221	1"1/2 extensible cromado	6,38
	03236	Antiolor ABS cromado y tubo inox. 1"1/4x32mmx600mm	12,40

ACCESORIOS PARA SIFÓN LATÓN CROMADO

	CÓDIGO	MEDIDA	€
	07413	Tubo 32 mm. x 30 cm.	5,20
	07901	Tubo 32 mm x 80 cm.	15,14
	07652	Tubo 32 mm. x 30 cm. abocardado	5,40
	07355	Tubo 32 mm. x 30 cm. flexible	7,24
	07153	Tubo telesc. M -H 13 cm.	6,20
	07211	Unión 32 mm.	2,80
	07216	Unión red. 40 x 32 mm.	6,60
	07902	Florón 32 mm.	1,10
	07056	Tuerca	1,60
	07389	Codo tuerca y junta cónica	10,50

SIFÓN LATÓN CROMADO PARA BIDET

	CÓDIGO	MEDIDA	€
	03110	1"1/4	13,90

RECOVAL

LAVABO/BIDET



CÓDIGO	MEDIDA	€
03111	1"1/4 botella extensible con válvula	5,26
03143	1"1/2 botella extensible con válvula	5,40
03112	1"1/4 botella extensible sin válvula	2,90
03146	1"1/2 botella extensible sin válvula	3,50

CONJUNTO DESAGÜE BAÑERA PVC



CÓDIGO	MEDIDA	€
03115	1"1/2 - 40 PVC salida orientable con válvula	8,26

CONJUNTO DESAGÜE BAÑERA LATÓN PARA PVC



CÓDIGO	MEDIDA	€
01408	1"1/2 - 40	34,30

FREGADERA



CÓDIGO	MEDIDA	€
03113	1"1/2 curvo doble extensible con válvula	10,02
03114	1"1/2 curvo doble extensible sin válvula	6,60
03051	1"1/2 con toma electrodoméstico	3,72

PLAFÓN EMBELLECEDOR



CÓDIGO	MEDIDA	€
03052	20 mm - 59 mm partido	0,62
03182	32 mm - 73 mm partido	0,68
03181	40 mm - 73 mm partido	0,74
03202	32 x 17 mm	0,68
03203	40 x 17 mm	0,68
03053	8 x 15 mm	0,32
03186	15 x 25 mm	0,32
03120	32 x 35 mm	0,32
03204	40 x 45 mm	0,44

SIFON BAÑERA PVC



CÓDIGO	MEDIDA	€
03208	PVC autolimpiante	4,50

LAVADORA



CÓDIGO	MEDIDA	€
03099	empotrar	11,50

VÁLVULA LAVADERO 'EBRO'



CÓDIGO	MEDIDA	€
01409	latón cromado	23,20

MANGUITO UNION TUBO METALICO

NOVEDAD



CÓDIGO	MEDIDA	€
03259	32-28/35	3,50
03262	32-38/40	3,24
03260	40-28/35	3,84
03261	40-38/40	3,56

VÁLVULA SIFÓNICA PVC PLATO - DUCHA



CÓDIGO	MEDIDA	€
03116	1"1/2 x 80 mm	3,06

VÁLVULA SIFÓNICA LATÓN PLATO - DUCHA



CÓDIGO	MEDIDA	€
01405	SANGRÁ para PVC	19,60



01421	80 - 'lt'	21,60
-------	-----------	-------

ENLACE MIXTO



CÓDIGO	MEDIDA	€
03207	1"1/4 x 40	2,00
03050	1"1/2 x 40	2,04

DESAGÜE DUCHA "JAMES"



CÓDIGO	MEDIDA	€
03258	"James" normal D.90	30,44

03264	"James" normal D.60	29,64
-------	---------------------	-------



	"James" champiñón	32,00
--	-------------------	-------

DESAGÜE DUCHA ABS CROMO

NOVEDAD



CÓDIGO	MEDIDA	€
03265	ABS cromo D.90	29,50

VÁLVULA AUTOMÁTICA CLICK - CLACK



CÓDIGO	MEDIDA	€
01443	Latón cromado	17,00

Tapón normal



01445	Latón cromado	18,40
-------	---------------	-------

Tapón champiñón



01446	ABS cromado	4,80
-------	-------------	------

VÁLVULA LAVABO LATÓN CROMADO (con gomas)



CÓDIGO	MEDIDA	€
01400	3/4" tapón goma	9,20

01401	1" tapón goma	6,86
-------	---------------	------

01402	1"1/4 tapón goma	7,80
-------	------------------	------

01442	1"1/4 tapón l. cromado	9,86
-------	------------------------	------

VÁLVULA LAVABO ACERO INOX. SIN REBOSADERO



01412

CÓDIGO	MEDIDA	€
	Valv. 1"1/4 tapón goma	6,50

01412	Val. 1"1/4 tapón l. cromo	9,26
-------	---------------------------	------

TAPÓN LATÓN -CROMO



CÓDIGO	MEDIDA	€
01424	Para válvula lavabo	3,92

VÁLVULA AUTOMÁTICA PARA MONOMANDO



CÓDIGO	MEDIDA	€
01410	1"1/4	18,30

RECOVAL

VÁLVULA PVC FREGADERA



CÓDIGO	MEDIDA	€
03197	1"1/2 x 70 mm.	4,24
03223	1"1/2 x 115 mm. cesta	13,50
03224	1"1/2 x 115 mm.	18,10

VÁLVULA PVC LAVABO-BIDET



CÓDIGO	MEDIDA	€
03147	1"1/4 x 63 mm.	3,06
03257	1"1/2 x 70 mm.	3,08

VÁLVULA EXTENSIBLE LAVABO-BIDET



CÓDIGO	MEDIDA	€
03025	32 x 70 mm.	3,36
03026	40 x 70 mm.	3,36

VÁLVULA PVC PARA SIFÓN DE GOMA



CÓDIGO	MEDIDA	€
01404	Ø 30 mm.	2,56
01406	Ø 35 mm.	2,56
01413	Ø 40 mm. (antigua 35)	2,56

SUMIDEROS DE LATÓN CROMADO

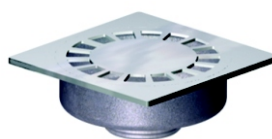

CÓDIGO	MEDIDA	€
07112	100 x 100 mm.	15,40
07121	120 x 120 mm.	28,60
07120	100 x 100 mm. a codo	28,46
07464	120 x 120 mm. a codo	24,44

RACORT 1"1/2 TOMA ELECTRODOMÉSTICO



CÓDIGO	MEDIDA	€
03027	racort 1"1/2 toma electrodoméstico	1,62



ENLACE MIXTO PVC M TOMA AUXILIAR



CÓDIGO	MEDIDA	€
03028	enlace mixto PVC M con toma auxiliar	1,82

SUMIDEROS ACERO INOX.



CÓDIGO	MEDIDA	€
07611	150 x 150 mm.	44,30
07119	200 x 200 mm.	67,16

REDUCTOR PVC



CÓDIGO	MEDIDA	€
03189	1"1/4	0,98
03108	1"1/2	0,98

SUMIDEROS ACERO INOX. CLICK - CLACK

NOVEDAD

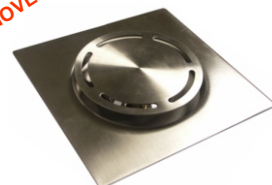



CÓDIGO	MEDIDA	€
07123	100 x 100 mm. salida 40 mm. apertura y cierre por pulsador	43,20

ACCESORIOS SANEAMIENTO

	CÓDIGO		€
	03188	rejilla inox. para válvula cesta	4,80
	03255	rejilla blanca para válvula cesta	4,38
	01439	cazoleta acero inox Ø 70 mm	0,50
	07406	filtro acero inox. para cazoleta	0,48
	07335	filtro con patas para cazoleta	0,60
	07057	cubreválvula latón cromado	7,20
	07631	cubreválvula maciza latón cromado	15,06
	01411	tornillo acero inox. M 6 x 70 mm.	0,32
	07655	Rejilla urinario inox.	2,88

TAPÓN GOMA

Mínimo bolsa de 25 ucd.

	CÓDIGO	MEDIDA	€
	07175	28 mm	0,38
	07165	30 mm	0,38
	07166	32 mm	0,38
	07167	34 mm	0,44
	07168	36 mm	0,44
	07169	38 mm	0,44
	07170	40 mm	0,46
	07171	42 mm	0,46
	07172	44 mm	0,50
	07311	46 mm sifón plástico	0,48
	07173	47 mm	0,50
	07174	50 mm	0,58
	07176	51 mm	0,58
	07177	55 mm	0,60
	07178	61 mm	0,74
	07321	TEKA - ROCA	0,72

COMPLEMENTOS PARA GRIFO

RECOVAL





ROSETA TAPA - AGUJEROS

	CÓDIGO		€
	07200	ABS cromada	0,66
	07437	ABS blanca	0,66
	07435	latón cromado	1,92
	07439	latón esmaltado blanco	1,92
	07440	latón cromado (maciza)	4,60
	07442	latón blanco (maciza)	3,68
	07151	inox. con espiga	0,58

ATOMIZADORES

	CÓDIGO		€
	07138	rosca M 24/100	1,44
	07139	rosca M 20/100	1,44
	07992	rosca H 22/100	1,44
	07225	rosca H 18/100	1,44
	07141	bañera 28	2,60
	07142	rótula M	4,58
	07099	rótula H	4,58
		Llave especial para desmontar atomizadores	5,90
	07001	Rociador fregadera Rotula dos posiciones M=H	3,36

CADENAS

	CÓDIGO	MEDIDA	€
	07155	cadena bolas (3,2 mm.)	1,04
	07156	cadena bolas (3,6 mm.)	1,32
	07157	cadena malla inox.	1,40
	07162	cadena montada 25 cm.	0,52
	07163	cadena montada 45 cm.	0,78



ACCESORIOS CADENAS

	CÓDIGO		€
	07158	óvalo hierro cromatizado	0,07
	07159	triángulo latón cromado	0,05
	07160	anilla llavero latón crom.	0,06
	07161	enganche cestillo	0,06

ATOMIZADORES AHORRO DE AGUA

	CÓDIGO		€
	07231	M24 ahorro agua	2,32
	07269	H22 ahorro agua	2,32
	07244	Economizador ducha M-H 1/2	2,60

TUBO BIFLEX CON ROCIADOR

	CÓDIGO		€
	07358	acoplamiento ABS M o H (con adaptador ABS)	5,96
	07412	adaptador I. cromado M = H	1,00
	07359	dos posiciones (con adaptador ABS)	6,90

GRIFO LAVADORA SENCILLO



CÓDIGO		€
07362	volante latón	5,66

GRIFO LAVADORA DOBLE



CÓDIGO		€
07361	volante latón	11,80

GRIFO LAVADORA LAVAVAJILLAS DOBLE



CÓDIGO	MEDIDA	€
07363	volante latón	12,00

ACOPLAMIENTO PARA LAVADORA



CÓDIGO	MEDIDA	€
07315		10,78

GRIFO LAVADORA CIERRE ESFERA



CÓDIGO	MEDIDA	€
07238	tipo 'B'	4,80



07241	con plafón	4,14
-------	------------	------

LLAVE ESFERA REGULACIÓN 'COMBI'



CÓDIGO	MEDIDA	€
07411	entrada 1/2 salida 3/8 y 3/4	11,00

LLAVE REGULACIÓN CIERRE ESFERA



07240

CÓDIGO		€
07240	A-80 larga 1/2"x 3/8"	5,14
07011	A-80 Antical	5,30



01123

07410	larga económ. 1/2"x3/8"	2,40
07417	corta tca. loca 1/2"x3/8"	5,04
07409	larga M-M 1/2"x1/2"	3,96



01122

01123	escuadra corta M -H 3/8"	3,22
01122	minimalista 1/2"x 3/8"	9,28

CONEXIÓN LAVADORA



CÓDIGO	MEDIDA	€
TUERCA PLÁSTICO		
05144	1,50 m	3,30
05145	2,00 m	3,76



CÓDIGO	MEDIDA	€
TUERCA LATÓN		
05200	1,50 m	3,80
05201	2,00 m	4,20

TUBO DESAGÜE LAVADORA

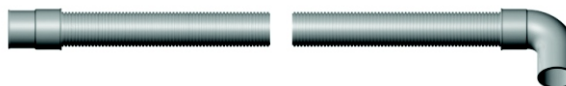

CÓDIGO	MEDIDA	€
05146	plástico N. E.	2,70



05158	polipropileno extensible de 60 a 200 cm.	4,64
-------	------------------------------------------	------

RECOVAL

GRIFO LAVABO 'APOLO'



CÓDIGO	MEDIDA	€
07239		11,42

GRIFO LAVABO LUXE



CÓDIGO	MEDIDA	€
46001		14,76

GRIFO FREGADERA



CÓDIGO	MEDIDA	€
07368	14 cm	9,38
07366	17 cm	13,20

GRIFO FREGADERA con atomizador



07243



07282

CÓDIGO	MEDIDA	€
07243	corto volante metal	12,20
07280	largo volante metal	12,30
07282	largo volante ABS	10,80

PLACA MEDIDORA DE MONTURAS

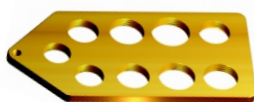

CÓDIGO	MEDIDA	€
07098	latón	29,20

MONTURA GRIFERÍA CERÁMICA

NOVEDAD



CÓDIGO	MEDIDA	€
07608	1/4 vuelta de 1/2"	4,76

MONTURA PULIDA LATÓN



CÓDIGO	MEDIDA	€
07188	15 mm	3,72
07190	17 mm	3,72
07191	18 mm	3,92
07192	19 mm	4,06
07193	20 mm	4,76
07194	21 mm	4,76
07195	22 mm	5,88
07196	23 mm	5,88
07199	26 mm	5,88
07622	30 mm	10,10

MONTURA VISTA RECAMBIO UNIVERSAL



CÓDIGO	MEDIDA	€
07290	3/8"	3,96
07314	1/2"	3,96
07014	16 mm	3,96
07180	17 mm	3,96
07334	18 mm	3,96
07291	19 mm	3,96
07292	20 mm	3,96
07293	21 mm	3,96
07461	22 mm	3,96

MONTURA EMPOTRAR RECAMBIO UNIVERSAL



CÓDIGO	MEDIDA	€
07333	3/8"	7,20
07319	1/2"	7,20
07619	16 mm	7,20
07181	17 mm	7,20
07294	18 mm	7,20
07295	19 mm	7,20
07296	20 mm	7,20
07198	21 mm	7,20
07309	22 mm	7,20

MONTURA VISTA VOLANTE FACETADO



CÓDIGO	MEDIDA	€
07620	1/2"	7,24
07620	18 mm	7,24
07620	19 mm	7,24
07620	21 mm	7,24

MONTURA EMPOTRAR VOLANTE FACETADO



CÓDIGO	MEDIDA	€
07621	1/2"	8,40
07621	18 mm	8,40
07621	19 mm	8,40
07621	21 mm	8,40

BATERÍA FREGADERA

	CÓDIGO	MEDIDA	€
	46011	caño tubo exc. 90-130	30,00
	46013	caño tubo exc. 130-170	32,00
	46014	caño fund. exc. 130-170	40,00

MONOMANDO LAVABO

	CÓDIGO		€
	26180		34,50
	26180RE	RECOMIX LUJO	43,72

MONOMANDO BAÑO - DUCHA

	CÓDIGO		€
	26010		48,38
	26010RE	RECOMIX LUJO	60,24





MONOMANDO DUCHA - EXTERIOR

	CÓDIGO		€
	26260		48,38
	26260RE	RECOMIX LUJO	51,92

MONOMANDO BIDET

	CÓDIGO		€
	26220		34,50
	26220RE	RECOMIX LUJO	41,12

JUEGO EXCÉNTRICAS

	CÓDIGO		€
	02236	normales con florón excentricidad = 3 cm	5,40
	02237	normales sin florón	2,86
	02257	SUPER con florón excentricidad = 5 cm	10,12
	02400	SUPER sin florón	7,04
	02800	GIGANTE con florón Excentricidad = 7 cm	18,00

GRIFOS FREGADERA

	CÓDIGO	MEDIDA	€
	46017	1/2" un agua pared giratorio	16,00
	46027	1/2" un agua pared giratorio largo 27 cm.	19,00
	46032	1/2" un agua encimera	20,00

CAÑO FREGADERA

	CÓDIGO	MEDIDA	€
	07203	caño empotrar 1/2"	29,50

GRIFERÍA TERMOSTÁTICA

	CÓDIGO		€
	60256	bañera	68,00
	60212	ducha	64,00

FLORONES PARA EXCÉNTRICAS

	CÓDIGO	MEDIDA	€
	02403	65 mm	1,30
	02404	80 mm	1,62
	02405	110 mm	4,76

RECOVAL

MONOMANDO FREGADERA

	CÓDIGO		€
	27010	monomando pared caño alto fundido	74,70
	27180	monomando pared caño bajo fundido	60,50
	27110	monomando repisa caño fundido horizontal	55,00
	27160	monomando vertical caño alto fundido	63,20
	27161	monomando vertical caño alto tubo	52,00
	26221	monomando repisa con ducha extraíble	74,50
	07661	ducha extraíble 'OMEGA' cromada	10,80
	05212	flexo inox. para ducha extraíble	10,84

CONJUNTO DUCHA HIGIÉNICO

	CÓDIGO		€
	07074	ducha blanca o negra	6,86
	07915	conjunto ducha con cierre Pulsador+flexo (en caja)	11,72





CONJUNTO DUCHA HIGIÉNICO LUJO

	CÓDIGO		€
	07075	todo cromado	14,00

MONOMANDO 'MEDICAL'

	CÓDIGO		€
		PARED	
	072100	fijo 1/2"- 25 cm. pared	113,80
	072101	giratorio 1/2"- 28 cm.	92,40
	072098	fregadera	118,44
		REPISA	
	072097	fregadera repisa	116,38

MONOMANDO PELUQUERÍA

	CÓDIGO		€
	46026	conjunto	140,68
		- monomando	
		- mango ducha M 3/8	
		- flexo H-H 3/8	
		- florón posaflexo	
	46020	monomando	109,68
	07076	mango ducha M 3/8	13,80
	07077	flexo H-H 3/8	6,74
	07078	Florón posaflexo	10,46

NOVEDAD

GRIFO TEMPORIZADO LAVABO



CÓDIGO		€
07234	repisa 20"	38,10
07235	pared 20"	30,78

MONTURA COMPLETA PARA GRIFO TEMPORIZADO



CÓDIGO		€
07628		19,84

GRIFO TEMPORIZADO PARA FUENTE



07087



07090

CÓDIGO	MEDIDA	€
07807	temporizado bronce	63,00
07090	1/2 pulsador pulido	23,72

GRIFO TEMPORIZADO DUCHA

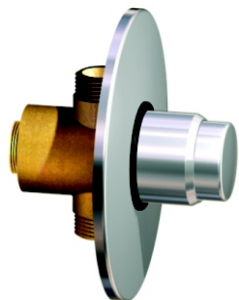

CÓDIGO		€
07805	empotrar 25" - 30"	44,12

GRIFO TEMPORIZADO URINARIO



07236

07202

CÓDIGO		€
07802	empotrar	50,50
07236	visto completo	39,80
07202	conexión compl. urinario	12,30

FLUXÓMETRO



CÓDIGO	MEDIDA	€
07205	'Grifstyl' 3/4"	136,68
07204	'Grifstyl' 1"	225,80

GRIFO PEDAL



CÓDIGO		€
60322	agua fría	100,11
60364	mezclador agua fría y caliente	146,20
60323	dos pedales	170,70

CAÑO GIRATORIO GRIFO PEDAL





CÓDIGO		€
07224	fundido	47,28





RECOVAL

CONEXIÓN ACERO INOXIDABLE Ø 13 mm STANDARD

	MEDIDA	15 cm	20 cm	25 cm	30 cm	35 cm	40 cm	45 cm	50 cm
	M 3/8" - H 3/8"	05110	05111	05134	05095	05142	05115	05143	05181
	H 3/8" - H 3/8"	05176	05204	05140	05096	05114	05172	05132	05175
	PRECIO €	1,40	1,50	1,60	1,80	1,90	2,00	2,20	2,30
	M 3/8" - H 1/2"	05214	05202	05141	05209	05139	05210	05116	05174
	M 1/2" - H 3/8"	05164	05162	05165	05113	05135	05105	05133	05173
	M 1/2" - H 1/2"	05163	05161	05178	05205	05160	05104	05169	05117
	H 1/2" - H 3/8"	05183	05203	05138	05206	05182	05166	05179	05213
	H 1/2" - H 1/2"	05208	05207	05112	05167	05168	05177	05211	05180
	PRECIO €	1,50	1,60	1,70	1,96	2,10	2,26	2,44	2,50

CONEXIÓN ACERO INOXIDABLE Ø 19 mm SUPER

	MEDIDA	20 cm	25 cm	30 cm	35 cm	40 cm	50 cm		
	M 1/2" - H 1/2"	05123	05186	05187	05188	05189	05190		
	H 1/2" - H 1/2"	05119	05120	05121	05122	05148	05131		
	PRECIO €	3,60	3,76	3,90	4,08	4,30	4,96		
	M 1/2" - H 3/4"	05191	05192	05193	05194	05195	05196		
	M 3/4" - H 1/2"	05197	05197	05199	05215	05216	05217		
	M 3/4" - H 3/4"	05126	05127	05128	05129	05130	05124		
	H 3/4" - H 1/2"	05218	05219	05220	05221	05222	05223		
	H 3/4" - H 3/4"	05224	05225	05226	05227	05228	05229		
	PRECIO €	3,92	4,18	4,46	4,74	5,04	6,02		

CONEXIÓN BATERÍA CONTADOR

	MEDIDA	30 cm	40 cm	50 cm	60 cm				
	3/4"	05136	05149	05150	05151				
	PRECIO €	8,80	9,56	10,28	10,84				
	1"	05137	05157	05155	05156				
	PRECIO €	13,06	13,60	14,80	16,06				

CONEXIÓN PARA GRIFERÍA (precio por juego)

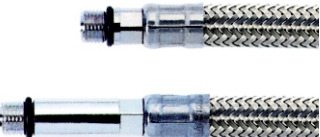
	MEDIDA	30 cm	40 cm	50 cm					
	M - 10	05147	05159	05184					
	PRECIO €	3,38	4,36	4,84					
	MEDIDA		40 cm						
	M - 10		05231	LARGO ESPECIAL					
	PRECIO €		4,60						

CODO SOPORTE DUCHA



CÓDIGO		€
07436	ABS cromado	0,64
07420	latón cromado	6,30

SOPORTE DUCHA



CÓDIGO	MEDIDA	€
07100	rótula y tornillo ABS	1,64
07101	rótula y tornillo l.cromado	3,50
07102	rótula y toma 1/2"	9,78
07365	bayoneta	2,64
07364	cónico giratorio blanco	2,88
07424	cónico giratorio cromado	3,38

SOPORTE TOMA



CÓDIGO	MEDIDA	€
07441	M1/2" codo con florón latón cromado	6,12
07051	M1/2" lujo	14,80

BRAZO DUCHA



CÓDIGO		€
07105	brazo ducha latón cromo 30 cm x 1/2" económico	5,96
07106	brazo ducha latón cromo SUPER con florón	6,70
07900	'Tarraco'	12,70
07998	brazo ducha latón cromo anti-vandálico (colegios...)	40,14

ROCIADOR DUCHA



CÓDIGO		€
07107	latón cromo	2,90
07109	plástico	1,06
07110	Ø 9 cm inox	2,10
07111	'Apolo' con rótula latón c.	7,40
07281	rociador c/rotula antical. 20 x 20 mm	41,20

RÓTULA PARA ACOPLAR A ROCIADORES



CÓDIGO	MEDIDA	€
07010	M - H 1/2"	7,28

CONJUNTO Y BARRA DUCHA



CÓDIGO		€
07425	barra ducha deslizante latón cromado	16,12
07232	conjunto tipo "G" barra+ducha+flexo	34,00

LIMITADOR DE CAUDAL DE AGUA



CÓDIGO		€
07603	1/2". Caudal 7l/minuto M-H 1/2"	12,00

MANGOS DUCHA Y FLEXOS

RECOVAL

MANGOS DUCHA ABS 1 POSICIÓN



CÓDIGO	MEDIDA	€
07103	económico codo ABS blanco o negro	1,74



07094	'VERONA' codo ABS. Bl.	4,34
07089	'VERONA' codo ABS. N.	4,34



07660	antical. Cromado	6,62
-------	------------------	------

MANGO DUCHA AHORRO DE AGUA



07122	Bajo consumo. Blister Reduce el consumo hasta un 50%	5,08
-------	------------------------------------------------------	------

FLEXO DUCHA EXTENSIBLE INOX.



CÓDIGO	MEDIDA	€
05097	1,70 - 2,00 m. 'COBRA'	7,72

MANGOS DUCHA ABS HIDROMASAJE



CÓDIGO	MEDIDA	€
07990	tipo 'GRH' 4 posiciones	17,44



CÓDIGO	MEDIDA	€
07427	tipo 'GRH' 2 posiciones	12,00



CÓDIGO	MEDIDA	€
07610	'TURIA' codo ABS. Cr. 2p.	5,62
07612	'TURIA' codo ABS. Bl. 2p.	3,70



07096	'990' Cromado 4p. blister	11,86
-------	---------------------------	-------

FLEXO DUCHA METÁLICO



CÓDIGO	MEDIDA	€
05102	1,50 m. CÓNICO	4,38
05098	1,70 m. CÓNICO	4,60
05103	2,00 m. CÓNICO	5,10
05100	1,50 m. cónico REFORZADO	7,16
05099	1,75 m. cónico REFORZADO	9,50
05101	2,00 m. Cónico REFORZADO	11,18

ASIENTO DUCHA ABATIBLE



CÓDIGO	MEDIDA	€
RDA		267,40

ASIDERO METÁLICO PARA BAÑERA



CÓDIGO	MEDIDA	€
07352	25 cm. cromado	22,54
07353	25 cm. blanco	22,54
07916	35 cm. cromado	28,00
07919	50 cm. cromado	36,00
07609	con forma cromado	33,40

TOALLERO PARRILLA



CÓDIGO	MEDIDA	€
07917	Medidas 610 x 267 mm.	66,88



DISPENSADOR TOALLITAS 25 x 32 x 15 cm.



CÓDIGO	MEDIDA	€
07017	blanco	47,80

DOSIFICADOR DE JABÓN LÍQUIDO



03170

CÓDIGO	MEDIDA	€
03170	'DOSICO 1000' 1 litro	22,68
07918	acero inoxidable	19,24

PORTARROLLOS REDONDO Ø 25 x 12 cm.



CÓDIGO	MEDIDA	€
07016	blanco	48,32

EJE PORTARROLLOS



CÓDIGO	MEDIDA	€
07150		0,40

RECOVAL

ABRAZADERA SIN FIN



CÓDIGO	MEDIDA	€
07252	12 - 20 mm	0,52
07632	16 - 25 mm	0,54
07250	25 - 40 mm	0,64
07251	30 - 45 mm	0,64
07253	32 - 50 mm	0,68
07254	35 - 45 mm	0,68

GRAPA 1 PATA



CÓDIGO	MEDIDA	€
07271	12 mm	0,04
07634	14 mm	0,04
07272	15 mm	0,04
07637	18 mm	0,06
07274	20 mm	0,06
07639	28 mm	0,10
07276	32 mm	0,12
07277	40 mm	0,22

ABRAZADERA PARA DESAGÜE PVC



CÓDIGO	MEDIDA	€
07680	75 mm	1,08
07640	90 mm	1,30
07658	110 mm	1,54
07641	125 mm	1,74

GRAPA PUENTE



CÓDIGO	MEDIDA	€
07288	12 mm	0,06
07289	15 mm	0,06
07370	16 mm	0,08
07374	20 mm	0,08
07371	22 mm	0,10
07373	28 mm	0,12
07278	32 mm	0,16
07279	40 mm	0,24

CINTA PERFORADA GALVANIZADA



CÓDIGO	ancho x grosor x largo	€
07350	17 mm x 0,8 mm x 10 m	4,80

TORNILLO PARA ABRAZADERA



CÓDIGO	MEDIDA	€
03163	M 6 x 30 mm	0,04
03164	M 8 x 40 mm	0,07
03237	M 8 x 60 mm	0,12

TORNILLOS



CÓDIGO	MEDIDA	€
07020	4,2 x 30	0,03
07021	4,2 x 40	0,04
07022	5 x 25	0,04
07023	5 x 30	0,05
07024	5 x 35	0,05

ABRAZADERA CON TIRAFONDO M 6 x 30



CÓDIGO	MEDIDA	€
07257	12 mm	0,14
07259	15 mm	0,16
07260	16 mm	0,16
07261	18 mm	0,18
07262	20 mm	0,20
07263	22 mm	0,22
07375	28 mm	0,24

ABRAZADERA TIRAFONDO NEGRA



CÓDIGO	MEDIDA	€
07665	15-16 mm.	0,20
07659	18 mm.	0,22
07666	22 mm.	0,24
07670	28 mm.	0,26

ABRAZADERA DOBLE CON TIRAFONDO M 6 x 30



CÓDIGO	MEDIDA	€
07372	10 - 12 mm	0,24
07638	14 - 15 mm	0,28
07629	18 - 20 mm	0,32
07388	22 mm	0,34

ABRAZADERA DOBLE TIRAFONDO NEGRA



CÓDIGO	MEDIDA	€
07662	14-16 mm.	0,36
07667	18-20 mm.	0,38
07668	22 mm.	0,42
07669	28 mm.	0,48

CLIP FIJATUBOS SIMPLE CON CASQUILLO



CÓDIGO	MEDIDA	€
03151	12 mm	0,24
03152	14 - 15 mm	0,26
03153	16 - 18 mm	0,34
03154	20 - 22 mm	0,36
03155	28 mm	0,38
03156	35 mm	0,50

CLIP FIJATUBOS DOBLE



CÓDIGO	MEDIDA	€
03159	12 mm	0,46
03160	14 - 15 mm	0,50
03161	16 - 18 mm	0,62
03162	20 - 22 mm	0,64

ARANDELA PLANA ZINCADA



CÓDIGO	MEDIDA	€
07028	M-6 estrecha	0,015
07045	M-6 ancha	0,02
07029	M-8 estrecha	0,016
07046	M-8 ancha	0,04
07030	M-10 estrecha	0,028
07047	M-10 ancha	0,08

TUERCA HEXAGONAL ZINCADA



CÓDIGO	MEDIDA	€
07031	M-6	0,02
07032	M-8	0,03
07033	M-10	0,07
07034	M-12	0,10

VARILLA ROSCADA ZINCADA



CÓDIGO	MEDIDA	€
07035	M-6 x 1000	0,86
07036	M-8 x 1000	1,50
07037	M-10 x 1000	2,32
07038	M-12 x 1000	3,37

BRIDAS NILON Y TACOS BRIDA



CÓDIGO	MEDIDA	€
07039	Brida negra 3,6 x 200	0,03
07040	Brida negra 3,6 x 300	0,05
07041	Brida negra 3,6 x 370	0,05
07042	Brida negra 4,8 x 200	0,04
07043	Brida negra 4,8 x 300	0,06
07044	Brida negra 4,8 x 400	0,12
07025	Taco brida 8 mm.	0,07

TACO NYLON GRIS



CÓDIGO	MEDIDA	€
07630	Ø 5 mm	0,03
07401	Ø 6 mm	0,03
07403	Ø 8 mm	0,04
07404	Ø 10 mm	0,08

JUEGO DE TORNILLOS

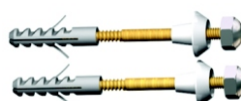
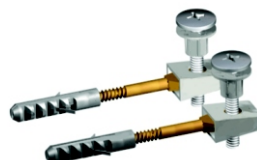
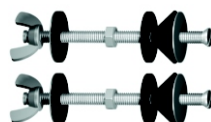

CÓDIGO	MEDIDA	€
01427	Jgo. tornillos acero inox. taza mochila tanque bajo	2,48
07400	juego tornillos sujeción lateral 'Góndola'	0,98
07643	Juego tornillos sujeción WC	1,08
07354	Juego tornillos sujeción lavabo M- 10	1,72

CONJUNTO SUJECIÓN MONOBLOC



CÓDIGO	MEDIDA	€
07009	conjunto sujeción monobloc	1,02

RECOVAL

SOPORTE LAVADERO 4 PATAS



CÓDIGO	MODELO	€
07512	HENARES 32,5 x 33,5 cm	23,88
07514	EURO EBRO (Sangrá) 30,5 x 29,5 cm	24,42
07515	EBRO ANTIGUO 39 x 42 cm	26,68
07516	ORFIL 32,5 x 39 cm	24,24

MUEBLE LAVADERO



CÓDIGO	MODELO	€
07460	BL - 40 38 cm. ancho 58 cm. fondo 79 cm. alto	51,60

SOPORTE LAVADERO 2 PATAS



CÓDIGO	MODELO	€
07513	HENARES 32,5 x 33,5 cm	21,46
07517	EURO EBRO (Sangrá) 32 x 32 cm	21,98
07518	EBRO ANTIGUO	24,24
07519	ORFIL	21,76

PLACA SEPARADORA PARA CONTADOR GAS

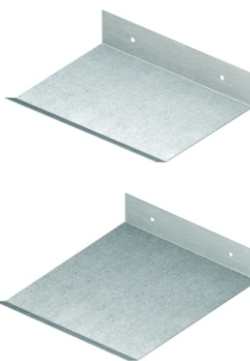

CÓDIGO		€
04178	frontal	2,94
04194	lateral	3,78

SOPORTES DE LAVABO Y FREGADERA

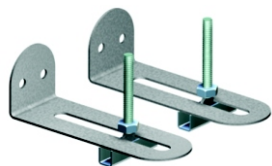

CÓDIGO		€
07423	Juego escuadras soporte lavabo	1,24

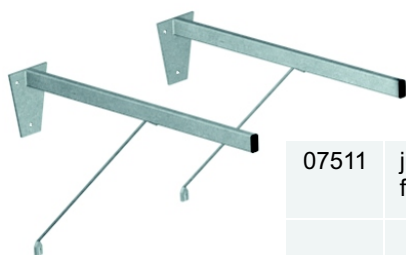

07511	juego soporte ZINCADO fregadera tirante 37 cm.	17,36
07523	juego soporte BLANCO fregadera tirante 37 cm.	20,88

SOPORTE CONTADOR GAS

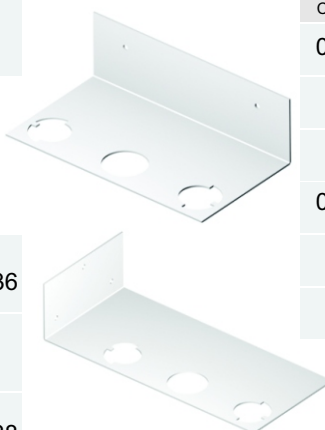

CÓDIGO		€
04149	frontal	2,40
04177	lateral	3,04

SOPORTES DE AIRE ACONDICIONADO (soldados)



04224	Jgo. soportes PEQUEÑO 20,00 40 cm.	
04225	Jgo. soportes MEDIANO 20,80 45 cm.	
04226	Jgo. soportes GRANDE 21,20 50 cm.	

CONJUNTO SILENT - BLOCK



CÓDIGO		€
04130	fijación a pata en bolsa con arandelas	2,96
04132	fijación a suelo en bolsa con arandelas	3,64

LLAVE GAS JUNTA PLANA M - M



CÓDIGO	MEDIDA	€
04120	V - 82 1/2"	6,90
04163	V - 83 3/4"	10,46

LLAVE GAS SOLDAR



CÓDIGO	MEDIDA	€
04116	V - 82 MCC Ø10 mm	11,50
04117	V - 83 MCC Ø12 mm	11,88

LLAVE GAS MONTANTE PALANCA



CÓDIGO	MEDIDA	€
04171	1/2"	8,98
04169	3/4"	10,06
04170	1"	14,44

REGULADOR BOTELLA BUTANO

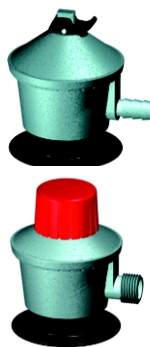

CÓDIGO	MEDIDA	€
04165	doméstico	11,69
04209	salida libre	12,20
04133	con corte	17,40

LLAVE GAS CONTADOR RECTA PALANCA



CÓDIGO	MEDIDA	€
04189	3/4"	14,66

MANGUERA PARA GAS BUTANO



CÓDIGO	LONGITUD	€/metro
04150	rollo de 60 m	0,92

CONEXIÓN PARA GAS



CÓDIGO	MEDIDA	€
04166	espirométrica con válvula de seguridad	29,96
	Válvula de seguridad	14,20

KIT RECAMBIO BUTANO



CÓDIGO	MEDIDA	€
04205	rollo 1,50 m + 2 abraz.	2,90
07651	abrazadera 14 x 16 mm	0,40

PURGADOR GAS TETILLA

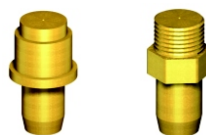

CÓDIGO	MEDIDA	€
04190	12 mm	0,94
04172	15 mm	0,94

BOQUILLA SOLDAR



CÓDIGO	MEDIDA	€
04122	Ø 10 mm	0,40
04123	Ø 12 mm	0,56

MANÓMETRO Ø 53 mm.



CÓDIGO	MEDIDA	€
07206	salida inferior	5,30
	salida posterior	5,30

VÁLVULA SEGURIDAD CON VALV. DE RETENCIÓN



CÓDIGO	MEDIDA	€
04200	1/2"	4,52
04227	1/2" super	6,70
04102	3/4"	10,70

RECOVAL

TUBO DE ALUMINIO EXTENSIBLE

CÓDIGO	MEDIDA	€/metro
04104	Ø 100 mm	3,08
04105	Ø 110 mm	3,40
04106	Ø 120 mm	3,66



DEFLECTOR DE VENTILACIÓN

CÓDIGO	MEDIDA	€
04210	Ø 100 mm	2,90
04211	Ø 110 mm	2,90
04212	Ø 120 mm	2,90
04164	Ø 130 mm	3,20



REJILLAS DE ALUMINIO PULIDO

CÓDIGO	MEDIDA	€
04138	100 x 100 mm lisa	0,88
04108	150 x 150 mm lisa	0,78
04109	170 x 170 mm lisa	0,90
04160	200 x 200 mm lisa	1,16
04183	300 x 300 mm lisa	8,10
04110	300 x 150 mm lisa	1,30
04121	200 x 100 mm lisa Vert.	0,88
04201	200 x 100 mm lisa Horiz.	1,06
04111	160 x 160 mm empotrar	1,30

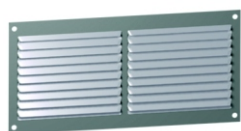

04201



04111

REJILLAS DE PVC

CÓDIGO	MEDIDA	€
04179	12 x 24 cm Baño	1,44
07430	12 x 24 cm regulable con palanca	2,60
	Marco para esta rejilla	0,60



REJILLAS DE ALUMINIO ESMALTADO BLANCO

CÓDIGO	MEDIDA	€
04153	100 x 100 mm lisa	1,02
04161	150 x 150 mm lisa	0,88
04162	170 x 170 mm lisa	1,30
04115	200 x 200 mm lisa	1,32
04182	300 x 300 mm lisa	7,50
04154	300 x 150 mm lisa	1,72
04206	200 x 100 mm lisa Horiz.	1,14
04155	100 x 200 mm lisa Vert.	1,14
04184	120 x 240 mm Baño	2,00
04173	160 x 160 mm empotrar	1,56



04206



04173

TOPE CIEGO CIERRE GRIFO



Mín. bolsa de 100 ud.

CÓDIGO	MEDIDA	€
08210	13 mm	0,04
08186	15 mm	0,04
08211	17 mm	0,04

SOLETA CON AGUJERO

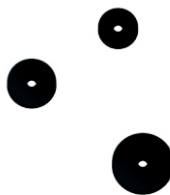

Mín. bolsa de 100 ud.

CÓDIGO	MEDIDA	€
08121	11 mm	0,04
08147	12 mm	0,04
08122	13 mm	0,04
08320	14 mm	0,04
08123	15 mm	0,04
08321	16 mm	0,04
08124	17 mm	0,04
08166	20 mm	0,10

VALVULITA 'TRIANON'



CÓDIGO	€
08133	0,98

JUNTA PLANA PARA GAS



Mín. bolsa de 100 ud.

CÓDIGO	MEDIDA	€
08325	7/8"	0,10
08327	1/2"	0,04
08328	3/4"	0,06

MEMBRANA DEDAL



CÓDIGO	€
08311 'Supergrif'	0,54

JUNTA PLANA NEGRA ESTRECHA PARA GRIFERÍA



Mín. bolsa de 100 ud.

CÓDIGO	MEDIDA	€
08125	3/8" n.e.	0,04
08126	1/2" n.e.	0,04
08127	3/4" n.e.	0,06
08128	1" n.e.	0,06
08177	1"1/4 n.e.	0,10
08216	1"1/2 n.e.	0,14

JUNTA PLANA NEGRA ANCHA PARA GRIFERÍA

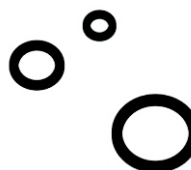

Mín. bolsa de 100 ud.

CÓDIGO	MEDIDA	€
08129	3/8" n.a.	0,04
08130	1/2" n.a.	0,04
08131	3/4" n.a.	0,06
08132	1" n.a.	0,06
08148	1"1/4 n.a.	0,10
08185	1"1/2 n.a.	0,14

JUNTA PLANA ESTRECHA TEFLÓN



Mín. bolsa de 100 ud.

CÓDIGO	MEDIDA	€
08307	3/8" e.	0,14
08305	1/2" e.	0,14
08306	3/4" e.	0,16
08309	1" e.	0,22

JUNTA PLANA ANCHA TEFLÓN



Mín. bolsa de 100 ud.

CÓDIGO	MEDIDA	€
08300	3/8" a.	0,14
08301	1/2" a.	0,14
08302	3/4" a.	0,16
08303	1" a.	0,22

JUNTA PLANA ESTRECHA KLINGERIT



Mín. bolsa de 100 ud.

CÓDIGO	MEDIDA	€
08139	3/8"	0,08
08140	1/2"	0,10
08141	3/4"	0,16
08142	1"	0,20
08188	1"1/4	0,28
08184	1"1/2	0,34

JUNTA PLANA ANCHA KLINGERIT



Mín. bolsa de 100 ud.

CÓDIGO	MEDIDA	€
08218	3/8"	0,08
08219	1/2"	0,10
08220	3/4"	0,16
08221	1"	0,20
08222	1"1/4	0,28
08223	1"1/2	0,34

RECOVAL

GOMA PLANA BLANCA PARA DESAGÜE

CÓDIGO	MEDIDA	€
08107	3/8"	0,12
08108	1/2"	0,12
08109	3/4"	0,12
08110	1"	0,14
08111	1"1/4	0,16
08187	1"1/2	0,16
08188	2"	0,16

GOMA CÓNICA BLANCA

CÓDIGO	MEDIDA	€
08149	3/8	0,32
08104	1/2"	0,30
08105	3/4"	0,30
08106	1"	0,30
08214	1"1/4	0,30
08326	1"1/2	0,30

GOMA CÓNICA TANQUE BAJO

CÓDIGO	MEDIDA	€
08144		0,60

GOMA CÓNICA PARA SIFÓN

CÓDIGO	MEDIDA	€
08330	32 mm	0,36
08331	40 mm	0,36
08334	reductora 40 - 32 mm	0,36

GOMA CIERRE PARA VÁLVULA WC

CÓDIGO		€
08112	CUELLO tanque bajo Medidas 17x68	0,44
08113	PLANA T. B. antigua pequeña Medidas 23x73	0,44
08903	'ROCA' antigua grande Medidas 33x68	0,44
08905	Nueva 'ROCA' Medidas 66x17	0,44
08169	tanque alto	0,88
08114	obturador valv. T. A. idrols	0,54

GOMAS PARA VÁLVULAS

CÓDIGO		€
08115	SEMIPLANA válv. fregadera y bañera	0,32
08902	para válvula fregadera sifón PVC	0,40
08208	goma cónica 'SANGRÁ'	0,58

GOMA SEMI-CÓNICA BLANCA

CÓDIGO	MEDIDA	€
08196	3/8	0,32
08175	1/2"	0,30
08176	3/4"	0,30
08178	1"	0,30
08103	1"1/4 (WC)	0,30
08207	1"1/2	0,30

GOMA DOBLE-CÓNICA PARA TANQUE BAJO

CÓDIGO	MEDIDA	€
08145		0,96

JUNTA RANURADA TAZA MOCHILA

CÓDIGO	MEDIDA	€
08313		0,70

GOMA CÓNICA PARA TUBO DE COBRE

CÓDIGO	MEDIDA	€
08116	3/8" x 10	0,07
08117	1/2" x 10	0,09
08118	1/2" x 12	0,09
08119	1/2" x 14	0,10

GOMA OBTURADOR PARA GRIFO FLOTADOR

CÓDIGO		€
08146	para flotador silencioso	0,12
08174	para flotador 'ROCA'	0,30

JUNTA CON FILTRO

CÓDIGO	MEDIDA	€
08333	1/2"	0,52
08168	3/4"	0,52

JUNTAS TÓRICAS

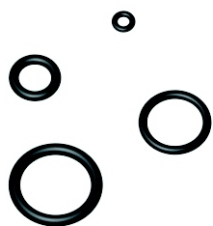

CÓDIGO	MEDIDA	€
08150	AN 1	0,04
08152	AN 2	0,04
08153	AN 3	0,04
08154	AN 4	0,04
08155	AN 5	0,06
08156	AN 6	0,06
08157	AN 7	0,06
08158	AN 8	0,06
08159	AN 9	0,06
08160	AN 10	0,06
08161	AN 11	0,08
08151	AN 12	0,08
08162	AN 13	0,08
08163	AN 14	0,08
08164	AN 15	0,08
08165	AN 16	0,08
08171	AN 17	0,10
08172	AN 18	0,10
08182	3/8"	0,05
08183	1/2"	0,06

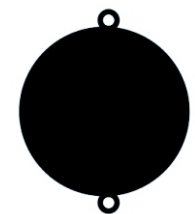
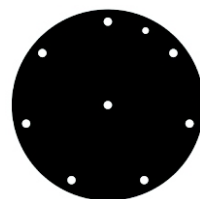
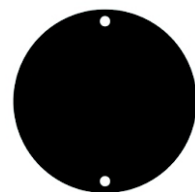

MEMBRANAS PARA CALENTADOR

CÓDIGO	MODELO CALDERA	€
nº 1	COINTRA, AGNI 5 L. moderno	1,08
nº 2	COINTRA, AGNI 10 L. moderno	1,08
nº 3	BALAY, 5 - 10 L. moderno	1,08
nº 4	CORBERO 5 L. antiguo	1,08
nº 5	CORBERO 5 L. moderno	1,08
nº 6	FAGOR, ASPES 10 L. antiguo	1,08
nº 7	FAGOR, ASPES 5 L. moderno	1,08
nº 8	FAGOR, ASPES 5 L. antiguo	1,08
nº 9	FAGOR, ASPES 10 L. antiguo	1,08
nº 10	FAGOR, ASPES 10 L. moderno	1,08
nº 11	ORBEGOZO 10 L. moderno	1,08
nº 12	ORBEGOZO 5 L. moderno	1,08
nº 13	VAILLANT 5 L. moderno	1,08
nº 14	VAILLANT 10 L. moderno	1,08
nº 15	JUNKERS 5 L. antiguo	1,08
nº 16	JUNKERS 10 L. antiguo.	1,08
nº 17	JUNKERS 10 L. moderno.	1,08
nº 18	COINTRA, AGNI 5 L. moderno	1,08
nº 19	OTSEIN 5 - 10 L. antiguo	1,08
nº 20	OTSEIN 5 - 10 L. antiguo	1,08
nº 21	OTSEIN 5 - 10 L. moderno	1,08
nº 22	CORBERO 5 L. moderno	1,08
nº 23	FAGOR, ASPES 10 L. antiguo	1,08
nº 24	BALAY	1,08
nº 25	BALAY	1,08
nº 26	CHAFFOTEAUX 5 - 10 L.	1,08
nº 27	TROPIK	1,08
nº 28	ORBEGOZO 10 L. moderno	1,08
nº 29	ORBEGOZO 5 L. moderno	1,08
nº 30	VAILLANT 5 L. moderno	1,08
nº 31	VAILLANT 10 L. moderno	1,08
nº 32	JUNKERS 5 L. antiguo	1,08
nº 33	JUNKERS 10 L. antiguo	1,08
nº 34	JUNKERS 10 L. moderno	1,08

ESTUCHE SURTIDO DE JUNTAS Y ARANDELAS

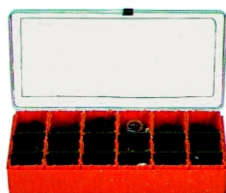

CÓDIGO		€
08135	FONTANERÍA	44,70
08136	TÓRICAS	75,74
08138	KLINGERIT	81,60
08310	TEFLÓN	64,00
08901	estuche vacío	11,42

RECOVAL

CORTATUBOS



CÓDIGO		€
04148	SUPER	10,58
04156	MINI	7,64
04151	cuchilla recambio	2,80

MUELLE PARA DOBLAR TUBOS



CÓDIGO	MEDIDA	€
04305	12 mm	4,36
04304	15 mm	5,54
04306	18 mm	5,68

FIBRA PARA LIMPIAR COBRE



CÓDIGO		€
04139	bolsa lana acero	1,46
04300	'DUROLIN'	6,66

PASTA DECAPANTE



CÓDIGO		€
04181	LACO - FLUX 125 gr.	7,82
04128	LACO - FLUX con pincel	8,70

GEL DECAPANTE



CÓDIGO		€
04146	S - 39 pequeño	3,80
04180	decapinzel	2,98

CAÑAMO



CÓDIGO		€
07126	madeja (precio por kilo)	12,00
04302	estopa bote 100 gr.	7,96
07149	masilla MASTIC ROS 400 gr.	4,08

ESTERINA



CÓDIGO		€
07127	paquete de 1 kg.	7,80

DESOXIDANTE EN POLVO BORAX



CÓDIGO		€
04185	100 Gr.	3,90

ESCUDO TÉRMICO PARA SOLDAR



CÓDIGO		€
04188	pack de 3 unidades	18,44
04103	blister 1 unidad	9,00

ESTAÑO COMÚN FONTANERÍA



CÓDIGO		€
04145	precio por kilo	

CARRETE ESTAÑO - PLATA



CÓDIGO		€
04144	100 gr. al 3,5%	
04143	250 gr. al 3,5%	
04141	250 gr. al 6%	

VARILLA PLATA



CÓDIGO	PRECIO POR KILO	€
04127	Al 5%	
04125	Al 20% desnuda	
04186	Al 20% recubierta	
04126	Al 30% desnuda	
04131	Al 30% recubierta	
04208	Fosforo P-8	

CARTUCHO MULTIGAS SEGÚN NORMA EN 417



CÓDIGO		€
04001	Quemador dardo 13	31,56
04002	Quemador dardo 18	20,64
04003	Quemador dardo 20	17,42
04004	Cartucho standard Capacidad:600 ml.-330 gr.	21,46
04005	Cartucho multiposición Capacidad:360 ml.-210 gr.	10,16



CARTUCHO SILICONA

	CÓDIGO		€
	07144	Transparente 280 ml.l	3,32
	07146	Blanca 280 ml.	3,32

PISTOLA PARA SILICONA

	CÓDIGO		€
	07147	normal	4,90
	07598	cromada con cremallera	7,20
	07599	'SKELETON' reforzada	8,68

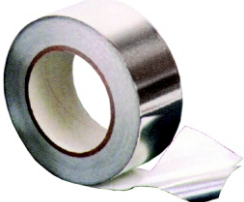
CINTA ADHESIVA

	CÓDIGO	MEDIDA	€
	03175	ALUMINIO 50 metros x 50 mm.	9,36
	03242	ALUMINIO 50 metros x 75 mm.	12,00
	03178	ALUMINIO 10 metros x 50 mm.	2,20
	03253	BLANCA 50 metros x 50 mm.	17,60
	03252	AMERICANA 25 metros x 50 mm	8,60

DESATASCADOR PISTOLA

	CÓDIGO		€
	07600	'PANGO'	58,00
	03199	presión aire	8,82

DESATASCADOR MUELLE

	CÓDIGO	LONGITUD	€
	08200	3 metros	10,00
	08201	5 metros	16,00

DESATASCADORES QUÍMICOS

	CÓDIGO		€
	07601	sólido "STEX"	8,60
	07602	líquido "GUTES-FORD" (1 litro)	24,00

NOVEDAD

TAPÓN ABS 'RECOTAP'

	CÓDIGO	MEDIDA	€
	03187	1/2" azul/rojo	0,50

ACONDICIONADOR MAGNETICO DESTRUCAL INOX.

	CÓDIGO		€
	07607	para lavadora y lavavajillas M - H 3/4	30,00
	07604	monomando M3/8-H1/2	30,00
	07605	ducha M - H 1/2	30,00

En blister

ACONDICIONADOR SANIMAX

	CÓDIGO		€
	07606		74,20

CARRETE TEFLÓN

	CÓDIGO		€
	07143	12 m x 12 mm x 0,1 mm	0,44
	07453	15 m x 19 mm x 0,2	0,58
	07428	50 m x 19 mm x 0,1 mm	3,82

TEFLÓN HILO / LÍQUIDO

	CÓDIGO		€
	04191	LOCTITE líquido	29,88
	04215	económico líquido	11,66
	07357	bote hilo 150 m	18,14

RECOVAL

SOPORTE HIERRO ZINCADO PARA RADIADOR

	CÓDIGO		€
	09503	triangular alicatar 95mm	0,56
	09530	1 patilla	0,48

SOPORTE PLÁSTICO PARA RADIADOR

	CÓDIGO		€
	09532	1 patilla	0,54

TAPÓN REDUCCIÓN ZINCADO PARA RADIADOR

	CÓDIGO	MEDIDA	€
	09525	1" - 1/8" izquierda	0,60
	09500	1" - 1/8" derecha	0,60
	09510	1" - 1/4" izquierda	0,60
	09504	1" - 1/4" derecha	0,60
	09524	1" - 3/8" izquierda	0,60
	09501	1" - 3/8" derecha	0,60
	09523	1" - 1/2" izquierda	0,60
	09502	1" - 1/2" derecha	0,60

TAPÓN ZINCADO PARA RADIADOR

	CÓDIGO	MEDIDA	€
	09520	1" izquierda	0,60
	09521	1" derecha	0,60

TAPÓN PURGADOR ZINC. PARA RADIADOR

	CÓDIGO	MEDIDA	€
	09517	1" izquierda automático	6,00
	09519	1" derecha automático	6,00

JUNTA PARA TAPÓN RADIADOR 1"

	CÓDIGO		€
	08308	TEFLÓN	0,32
	09505	'ÚTIL' polyester	0,14
	08189	grafitada	0,28

PLAFÓN PVC RÍGIDO BLANCO

	CÓDIGO		€
	09508	sencillo	0,30
	09506	doble	0,66
	09512	sencillo STAR	0,28
	09513	doble STAR	0,56
	09516	sencillo cromo	0,84
	09515	doble cromo	1,20

PURGADOR

	CÓDIGO	MEDIDA	€
	09518	1/8" latón cr. orientable	0,80

PURGADOR CON FLOTADOR

	CÓDIGO		€
	09507	'Baby'	7,26

VÁLVULA ESCUADRA SOLDAR 'MIDI'

	CÓDIGO	MEDIDA	€
	09511	1/2" - 15 cm	7,30

DETENTOR ESCUADRA SOLDAR 'MIDI'

	CÓDIGO	MEDIDA	€
	09514	1/2" - 15 cm	6,68

CURVA 90° M - H 1a Cu

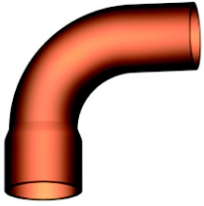

MEDIDA	
12	0.84
14	0.78
15	0.72
16	0.84
18	1.22
22	1.70

TE IGUAL H 130 Cu igual

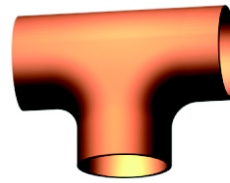

MEDIDA	
12	0.96
14	0.82
15	0.68
16	1.04
18	1.46
22	2.50

CURVA 90° H - H 2a Cu

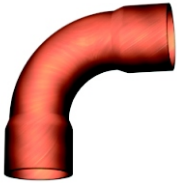

MEDIDA	
12	0.54
14	0.64
15	0.60
16	0.76
18	0.88
22	1.32

TE REDUCIDA H 130 Cu R

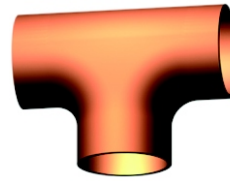

MEDIDA	
15 - 12 - 15	1.68
15 - 18 - 15	4.22
18 - 15 - 12	9.60
18 - 15 - 15	2.46
18 - 15 - 18	1.38
18 - 18 - 15	2.58
18 - 22 - 18	5.82
22 - 15 - 15	3.74
22 - 15 - 18	4.10
22 - 15 - 22	1.72
22 - 18 - 22	3.22

CURVA 45° M - H 40 Cu



MEDIDA	
12	1.34
14	1.04
15	0.52
16	1.32
18	1.52
22	1.48

MANGUITO H - H 270 Cu

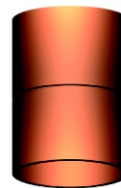

MEDIDA	
10	0.36
12	0.32
14	0.24
15	0.24
16	0.28
18	0.34
22	0.62

CURVA 45° H - H 41 Cu



MEDIDA	
12	1.78
14	0.86
15	0.60
16	0.96
18	1.46
22	1.70

REDUCCIÓN H - H 240 Cu



MEDIDA	
12 - 10	1.64
15 - 12	0.96
15 - 14	1.18
16 - 14	0.80
16 - 15	1.74
18 - 12	2.16
18 - 15	0.88
18 - 16	1.34
22 - 12	4.76
22 - 15	2.24
22 - 18	1.50
28 - 22	2.40

CODO 90° M - H 92 Cu

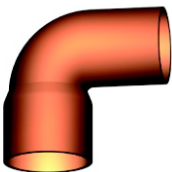

MEDIDA	
12	1.14
14	0.68
15	0.56
16	0.82
18	1.30
22	1.96

REDUCCIÓN M - H 243 Cu



MEDIDA	
12 - 10	1.38
15 - 14	1.42
16 - 15	1.46
18 - 12	1.74
18 - 15	0.58
18 - 16	1.04
22 - 15	1.18
22 - 18	1.20

CODO 90° H - H 90 Cu

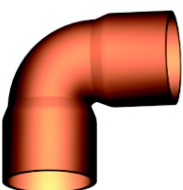

MEDIDA	
12	0.54
14	0.50
15	0.46
16	0.60
18	0.64
22	1.14

RECOVAL

TAPÓN H 300 Cu

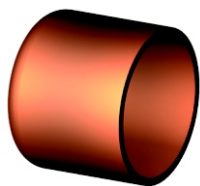

MEDIDA	
12	1.66
14	1.66
15	1.00
16	1.84
18	1.04
22	1.80

CURVA DESVIACIÓN H - H 85 Cu

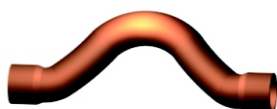

MEDIDA	
15	3.46
18	9.30
22	11.62

TUBERÍA COBRE

NOVEDAD

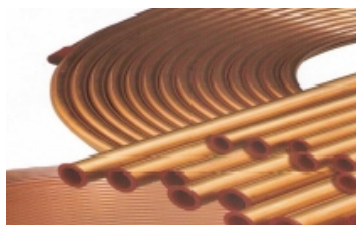

CÓDIGO	MEDIDA	€
TUBO COBRE EN ROLLO		
100209	15 x 1 metro	
100210	18 x 1 metro	
100211	22 x 1 metro	
<i>Consultar precios y otras medidas</i>		
TUBO COBRE EN TIRAS		
100309	15 x 1 metro	
100314	18 x 1 metro	
100315	22 x 1 metro	
<i>Consultar precios y otras medidas</i>		

RACOR RECTO 359 g Cu



MEDIDA	
10 - 3/8"	0,80
12 - 1/2"	0,75
12 - 3/8"	0,80
14 - 1/2"	0,81
14 - 3/8"	0,86
15 - 1/2"	0,73
15 - 3/4"	1,29
15 - 3/8"	0,86
16 - 1/2"	0,89
16 - 3/4"	1,37
18 - 1/2"	0,91
18 - 3/4"	1,17
18 - 1"	2,20
22 - 1/2"	1,91
22 - 3/4"	1,26
22 - 1"	1,94

RACOR CURVO 2a g Cu

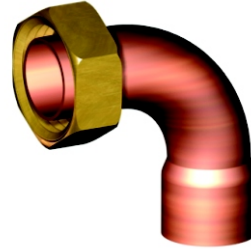

MEDIDA	
10 - 3/8"	1,25
12 - 1/2"	1,21
12 - 3/8"	1,25
14 - 1/2"	1,23
15 - 1/2"	1,20
15 - 3/4"	1,93
15 - 3/8"	1,26
16 - 1/2"	1,26
16 - 3/4"	1,94
18 - 1/2"	1,40
18 - 3/4"	1,93
18 - 1"	3,76
22 - 3/4"	1,99
22 - 1"	3,11

CODO HEMBRA 90 g Cu



MEDIDA	
12 - 1/2"	1,22
14 - 1/2"	1,15
15 - 1/2"	1,13
15 - 3/4"	1,92
16 - 1/2"	1,35
18 - 1/2"	1,29
18 - 3/4"	2,32
22 - 1/2"	2,06
22 - 3/4"	2,32
22 - 1"	3,32
28 - 1"	4,18

CODO M 92 g Cu

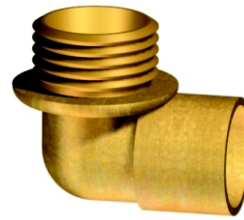

MEDIDA	
12 - 1/2"	1,17
14 - 1/2"	1,23
15 - 1/2"	1,18
16 - 1/2"	1,54
18 - 1/2"	1,26
18 - 3/4"	1,60
22 - 1/2"	1,84
22 - 3/4"	2,39
28 - 1"	4,40

CODO PLACA 471 g Cu



MEDIDA	
14 - 1/2"	1,72
15 - 1/2"	1,78
18 - 1/2"	2,27
22 - 3/4"	3,43
28 - 1"	6,66

TE H 130 g Cu

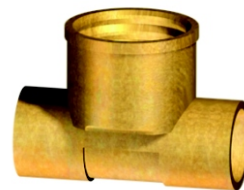

MEDIDA	
12 - 1/2"	1,62
14 - 1/2"	1,49
15 - 1/2"	1,38
16 - 1/2"	1,54
18 - 1/2"	1,70
18 - 3/4"	2,62
22 - 1/2"	2,38
22 - 1"	4,13
28 - 1"	5,53

ENLACE HEMBRA 270 g Cu



MEDIDA	
12 - 1/2"	0,74
14 - 1/2"	0,79
15 - 1/2"	0,78
15 - 3/4"	1,20
16 - 1/2"	0,80
18 - 1/2"	0,86
18 - 3/4"	1,31
22 - 1/2"	1,16
22 - 3/4"	1,33
22 - 1"	1,90
28 - 3/4"	2,04
28 - 1"	2,08

ENTRONQUE M 243 g Cu



MEDIDA	
12 - 1/2"	0,74
14 - 1/2"	0,78
15 - 1/2"	0,74
15 - 3/4"	1,14
16 - 1/2"	0,74
18 - 1/2"	0,81
18 - 3/4"	1,08
22 - 3/4"	1,28
22 - 1"	2,00
28 - 3/4"	2,48
28 - 1"	2,06

RACORERÍA LATÓN PARA POLIETILENO

RECOVAL

UNIÓN TUBO - MACHO



CÓDIGO	MEDIDA	€
02460	1/2" - 20 mm	2,32
02461	3/4" - 25 mm	3,78
02462	1" - 32 mm	5,74
02463	1"1/4 - 40 mm	11,72
02464	1"1/2 - 50 mm	16,50
02465	2" - 63 mm	27,00

UNIÓN TUBO - TUBO



CÓDIGO	MEDIDA	€
02454	20 mm	4,00
02455	25 mm	6,12
02456	32 mm	9,12
02457	40 mm	18,28
02458	50 mm	25,16
02459	63 mm	40,88

CODO TUBO - TUBO



CÓDIGO	MEDIDA	€
02472	20 mm	4,72
02473	25 mm	7,24
02474	32 mm	11,12
02475	40 mm	23,28
02476	50 mm	38,04
02477	63 mm	57,45

UNIÓN TUBO - HEMBRA



CÓDIGO	MEDIDA	€
02466	1/2" - 20 mm	3,14
02467	3/4" - 25 mm	4,00
02468	1" - 32 mm	5,86
02469	1"1/4 - 40 mm	11,58
02470	1"1/2 - 50 mm	18,18
02471	2" - 63 mm	30,46

CODO TUBO - HEMBRA



CÓDIGO	MEDIDA	€
02484	1/2" - 20 mm	3,72
02485	3/4" - 25 mm	5,72
02486	1" - 32 mm	9,40
02487	1"1/4 - 40 mm	16,64
02488	1"1/2 - 50 mm	30,30
02489	2" - 63 mm	46,52

CODO TUBO - MACHO



CÓDIGO	MEDIDA	€
02478	1/2" - 20 mm	3,58
02479	3/4" - 25 mm	5,42
02480	1" - 32 mm	9,12
02481	1"1/4 - 40 mm	16,90
02482	1"1/2 - 50 mm	29,10
02483	2" - 63 mm	43,70

TE TUBO - HEMBRA



CÓDIGO	MEDIDA	€
02502	1/2" - 20 mm	5,26
02503	3/4" - 25 mm	8,04
02504	1" - 32 mm	13,66
02505	1"1/4 - 40 mm	26,46
02506	1"1/2 - 50 mm	40,60
02507	2" - 63 mm	70,00

TE TUBO - TUBO



CÓDIGO	MEDIDA	€
02490	20 mm	6,16
02491	25 mm	9,64
02492	32 mm	15,80
02493	40 mm	32,86
02494	50 mm	49,96
02495	63 mm	81,40

PEDIDOS

Para evitar errores rogamos codifiquen sus pedidos.

Los pedidos inferiores a 120 € tendrán que ser recogidos en nuestro almacén y abonar su importe al contado.

PORTES

Todo pedido superior a 480 € (impuestos no incluidos) se enviará a portes pagados.

Para Catalunya el importe mínimo para portes pagados será de 300€.

Los portes correspondientes a los pedidos que se soliciten urgentes y que necesiten de otra agencia distinta a la que tengamos contratada, serán por cuenta del cliente.

RECEPCIÓN

Se recomienda la verificación del número de bultos recibidos y buen estado del embalaje. Cualquier anomalía debe ser comunicada de inmediato al transportista, haciéndolo constar en el albarán de entrega del transportista.

GARANTÍA

La garantía cubre el cambio de las piezas defectuosas, así como los portes que se originen, siempre y cuando los defectos no sean causados por una manipulación o uso anormal.

En ningún caso nos haremos responsables directa o indirectamente de daños y perjuicios que por defecto del producto hayan podido producirse.

DEVOLUCIONES

Para admitir una devolución deberá comunicarlo previamente y remitir el material con albarán indicando los detalles (cantidad y motivo detallado de la devolución).

Los portes de las devoluciones de material serán a cargo del cliente.

Los abonos por devoluciones de material no defectuoso a partir de 3 meses fecha factura, tendrán un demérito no inferior al 10% sobre el valor neto del producto.

No se aceptarán devoluciones de material a partir de los 6 meses fecha factura.

FORMA DE PAGO

Reposición dentro de 30 días fecha factura: 3% descuento.

Giros 30 y 60 días fecha factura.

Giros superiores a 60 días fecha factura tendrán un recargo del 1,5% mensual.

TARIFA

La presente tarifa sustituye a las anteriores.

Los precios son de venta al público (recomendables) y pueden ser modificados sin previo aviso.

CLAUSULA DE RESERVA DE DOMINIO

Las mercancías entregadas a cualquier comprador son de la propiedad de SUMINISTROS RECOVAL, S.L., hasta que se hayan satisfecho íntegramente las cantidades pactadas. En consecuencia en caso de impago de cualquier importe por parte del comprador, el vendedor podrá proceder, sin formalidades, a la recuperación de la mercancía. Las cantidades ya pagadas quedarán en propiedad del vendedor a título de perjuicios e intereses.

JURISDICCION

Serán competentes los Juzgados y Tribunales de Barcelona en relación con cualquier litigio que pudiera surgir en el marco de la relación contractual entre el comprador y el vendedor.

Enero 2009

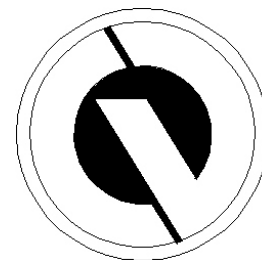

SUMINISTROS RECOVAL, S. L.

C. Agregación, 39 - 41
08041 Barcelona

Tel : 93 347 55 81

Fax: 93 433 18 96

e-mail: recoval@coacb.com

www.recoval.es